

Connector (Hirose Electric)

Output type	Parts Number
Open Collector	DF3-5S-2C
Line Driver	DF3-9S-2C

18S Series



18M Series



Electrical spec

Output Type	A, B, Z (index signal)	
Resolution	100, 160, 200, 300, 360, 400, 500, 800, 1000, 1024, 1600	200, 300, 360, 400, 500, 800, 1000, 1024, 1600
Supply voltage	Line driver	DC4.5~5.5V
	Open collector	DC4.5~13.2V
Current consumption	30mA (Max)	
Output current	20mA (Max)	
Operating frequency	240kHz (Max)	

Mechanical spec

Shaft diameter	Φ2.5	Φ2.5 (Option Φ3~Φ6)
Sealing	IP 50	—
Starting torque	4.9×10 ⁻⁴ N·m or Less	—
Allowable load to the shaft	Thrust : 4.9N / Radial : 2.94N	—
Moment of inertia	1×10 ⁻⁸ kg·m ² (Max)	8×10 ⁻⁸ kg·m ² (Max)
Rotating speed	6000r/min. (Max)	18000r/min. (Max)

18S Series

Type **18S** - - - - **15** - **00 E**
 Resolution Refer to above
 Cable length 15 : 15cm
 2MD : A, B, Z Line driver 1 : Backside cable output
 2MC : A, B, Z Open collector 2 : Side cable output

Dimensions (mm)

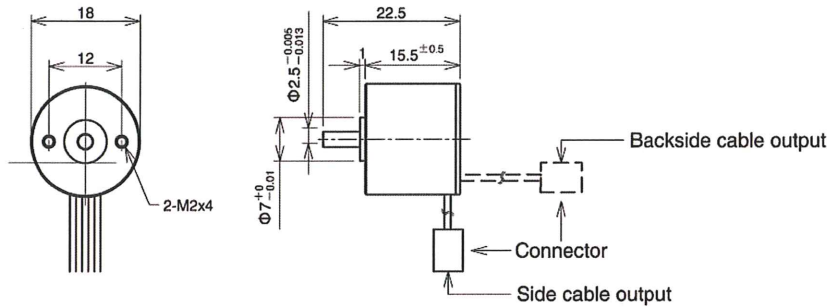

18M Series

Type **18M** - - - - **25** - **15** - **00 E**
 Resolution Refer to above
 Cable length 15 : 15cm
 Shaft size 25 : Φ2.5
 Mounting pitch A : Φ12
 B : Φ22
 2MD : A, B, Z Line driver
 2MC : A, B, Z Open collector

Dimensions (mm)

<Mounting pitch 12>

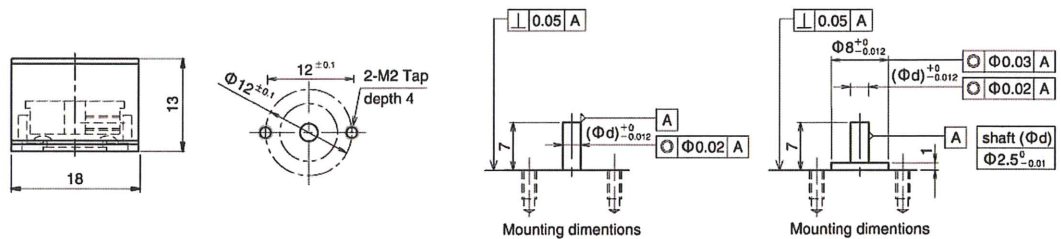

<Mounting pitch 22>

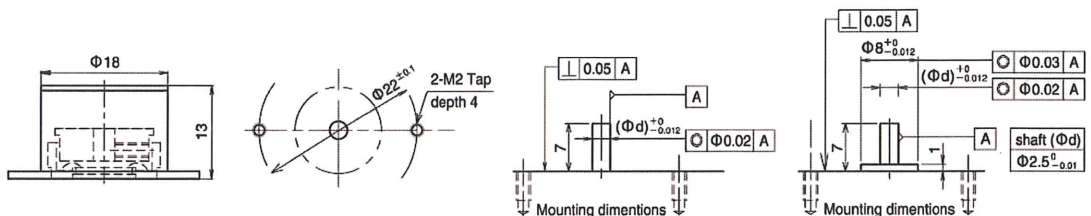

Φ18 / Φ38 Other Spec

Φ18 Cable assign

Open collector

Pin No.	Color	Connection
1	Brown	Vcc
2	Red	0V
3	Orange	Sig A
4	Yellow	Sig B
5	Green	Sig Z

Line driver

Pin No.	Color	Connection
1	Brown	Vcc
2	Red	0V
3	Orange	Sig A
4	Yellow	Sig A
5	Green	Sig B
6	Blue	Sig B
7	Purple	Sig Z
8	Gray	Sig Z
9	Black	—

38S / 38H Cable assign

Open collector / Complementary

Pin No.	Color	Connection
1	Red	Vcc
2	Black	0V
3	Blue	Sig A
4	White	Sig B
5	Yellow	Sig Z
6	Black	Shield

Line driver

Pin No.	Color	Connection
1	Red	Vcc
2	Black	0V
3	Green	Sig A
4	Blue	Sig A
5	White	Sig B
6	Gray	Sig B
7	Yellow	Sig Z
8	Orange	Sig Z
9	Black	Shield

Output style

Rotation direction

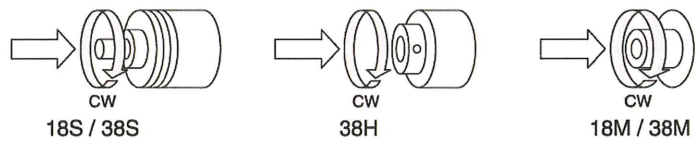

Open collector output / Complementary output : Signal A, B, Z

Line driver output : Signal A, B, Z, /A, /B, /Z

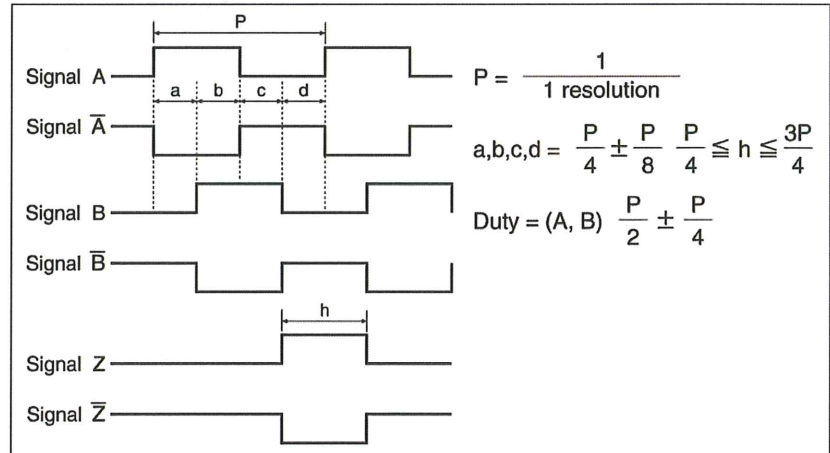

38M Connector assign

Open collector / Complementary

Pin No.	Connection
1	Vcc
2	0V
3	Sig A
4	—
5	Sig B
6	—
7	Sig Z
8	—
9	—
10	Shield
11	—

Line driver

Pin No.	Connection
1	Vcc
2	0V
3	Sig A
4	Sig A
5	Sig B
6	Sig B
7	Sig Z
8	Sig Z
9	—
10	Shield
10	—

Environmental spec

Operating temperature	-10°C ~ +85°C
Humidity	RH 85% Max*
Vibration	10~55Hz/1.5mm X, Y, Z direction each 2h
Shock	490m/s ² , 11ms X, Y, Z direction each for 3 times

*No Condensation

Circuit of Output Signal

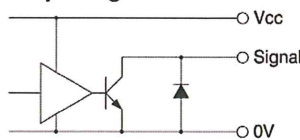

Open collector

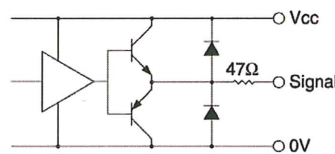

Complementary

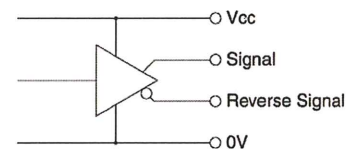

Line driver

NEMICON

AVAGO
TECHNOLOGIES

Nemicon is a group enterprise of Avago technologies.

Head Office

ORIX Shimbashi Bldg. 6F, 5-8-11, Shimbashi, Minato-ku, Tokyo
105-0004, Japan

Nagoya Sales Office

Sanko Marunouchi Bldg. 703, 3-18-1 Marunouchi, Naka-ku,
Nagoya-city, Aichi 460-0002, Japan

Osaka Sales Office

Hilton Plaza West Office Tower 19F, 2-2-2, Umeda,
Kita-ku, Osaka-City, Osaka 530-0001, Japan

Shirakawa Factory

12Tayuyashiki, Yashiroda, Omotego, Shirakawa-city, Fukushima
961-0404, Japan

Shanghai Liason Office, China

Room 606 ZhaoCheng Building No.120 Tianshan Rd.
(W) Changning District Shanghai, P.R.China 200335

URL <http://www.nemicon.co.jp>

E-mail encoder@nemicon.co.jp

Distributor